

DIODES

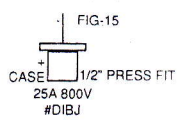
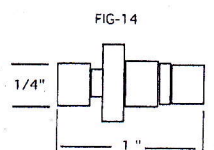
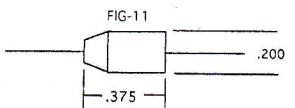
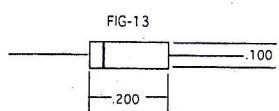
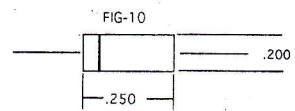
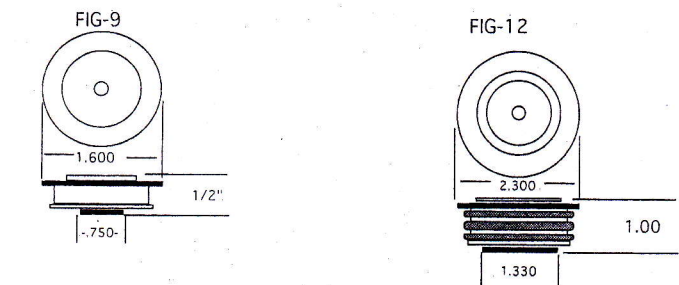
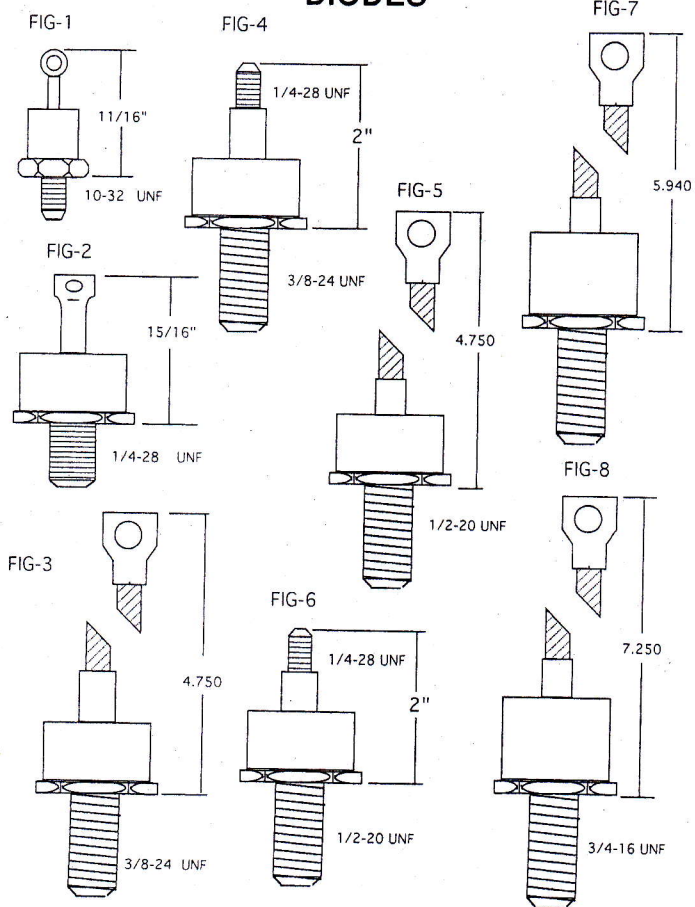

DIODES LISTING

AMPS	VOLTS	PT NO	FIG#	STUD POLR	DESCRIPTION	STK NO
1.0	600	1N4005	13		GENERAL PURPOSE (G P)	0012-325
1.5	600	F6	11		G P	0010-090
1.5	1200	S14120	10		G P USE #S1-12	0010-095
2.0	600	60LA	14		G P	0012-460
6.0	600	S6A6	10		G P	0012-780
6.0	1000	S6A10	10		G P	0012-783
16.0	1200	DIR	1	NEG	G P	001-006
16.0	600	DIO	1	POS	G P	0010-011
16.0	1200	DIS	1	POS	G P	0010-012
16.0	600	DIP	1	NEG	G P	0011-005
22.0	600	DIL	1	POS	G P	0010-009
22.0	1200	DIM	1	POS	G P	0010-010
22.0	1200	DIN	1	NEG	G P	0011-004
22.0	600	DIT	1	NEG	G P	0011-007
22.0	1400	DIM-14	1	POS	GP	0010-110
25.0	800	DIBJ	15	POS CASE	GP	
40.0	600	DIF	2	POS	G P	0010-005
40.0	1200	DIH	2	POS	G P	0010-006
40.0	600	DIG	2	NEG	G P	0011-002
40.0	1200	DIK	2	NEG	G P	0011-003
70.0	1200	DIA	2	POS	G P	0010-001
70.0	600	DIAM	2	POS	G P	0010-039
70.0	400	DIAX	2	POS	G P	0010-049
70.0	1200	DIE	2	NEG	G P	0011-001
70.0	600	DIAN	2	NEG	G P	0011-014
70.0	1400	DIBB	2	NEG	GP	0011-024
70.0	1200	DIBH	2	POS	FREE-WLG. & INVERTERS	
70.0	1200	DIBI	2	NEG	FREE-WLG. & INVERTERS	
150.0	1200	DIB	3	POS	G P	0010-002
150.0	600	DID	3	POS	G P	0010-004
150.0	200	DIX	3	POS	G P	0010-014
150.0	1200	DIZ	5	POS	G P	0010-016
150.0	1200	DIAB	4	POS	G P	0010-018
150.0	1200	DIAC	6	POS	FAST SWITCHING TYPE (F.S.)	0010-019
150.0	1200	DIAF	3	POS	F.S.(FREE-WLG.INVRTER,ETC.)	0010-021
150.0	1200	DIAS	4	POS	F.S.(FREE-WLG.INVRTER,ETC.)	0010-043
150.0	600	DIV	3	NEG	G P	0011-008
150.0	1200	DIW	3	NEG	G P	0011-009
150.0	1200	DIAE	4	NEG	G P	0011-010
150.0	1200	DIAG	6	NEG	G P	0011-011
150.0	1600	DIBE	5	1/2" NEG	GP-SEMICON SKN100/16	0011-027
150.0	1200	DIBG	3	NEG	FREE-WLG. & INVERTERS	
250.0	1200	DIAR	7	POS	F.S.(FREE-WLG.INVRTER,ETC.)	0010-040
250.0	1600	DIBA	7	NEG	F.S.(FREE-WLG.INVRTER,ETC.)	0011-023
250.0	1600	DIBD	7	POS	F.S.(FREE-WLG.INVRTER, ETC)	0010-109
300.0	600	DIU	7	POS	G P	0010-013
300.0	1200	DIAA	8		REPL/REL#405919-48AW	0010-017

AMPS	VOLTS	PT NO	FIG#	STUD POLR	DESCRIPTION	STK NO
300.0	1200	DIAD	7	POS	G P	0010-020
300.0	600	DIAZ	8	POS	G P	0010-027
300.0	200	DIAW	7	POS	G P	0010-048
300.0	1200	DI AJ	7	NEG	G P	0011-012
300.0	600	DI AK	7	NEG	G P	0011-013
300.0	1200	DI AY	7	NEG	F.S.(FREE- WLG,INVRTER, ETC)	0011-020
400.0	1200	DI AU	9		G P	0010-046
400.0	1200	DIB C	7	POS	GP	0010-108
1000.0	1200	DI AV	12		GENERAL PURPOSE (G P)	0010-047
		DI AH	3		REPL/REL#405919-43AC	0010-022
		DI AI	3		REPL/REL#405919-43AB	0010-023